

Magnum®

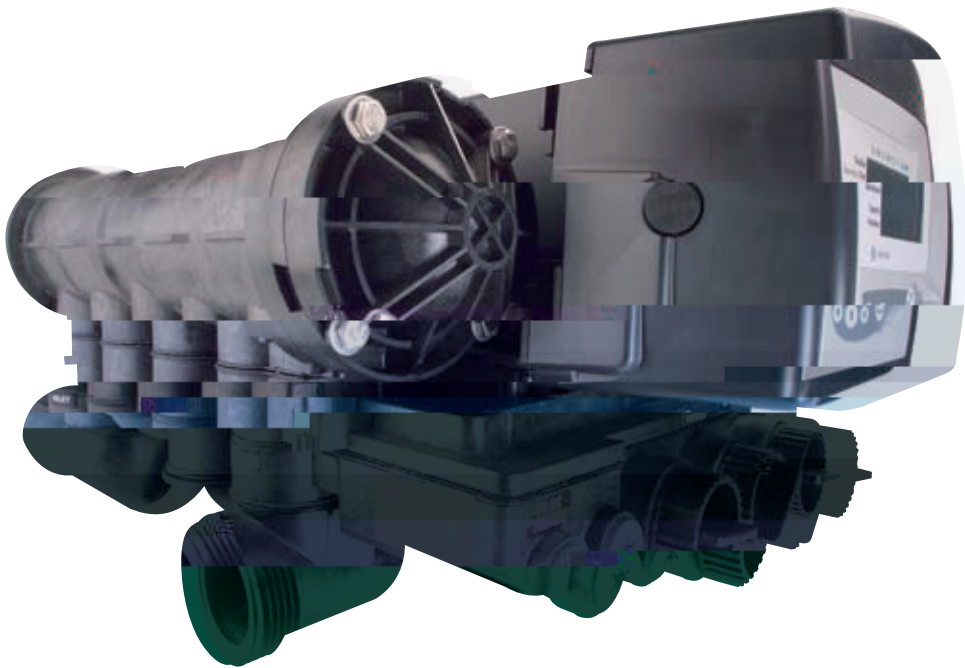

Magnum®

Logix™





h (17.3 m)
(20.2 m)
(Kv = 1)
y = 19.5

C

36

Magnum®

- Magnum

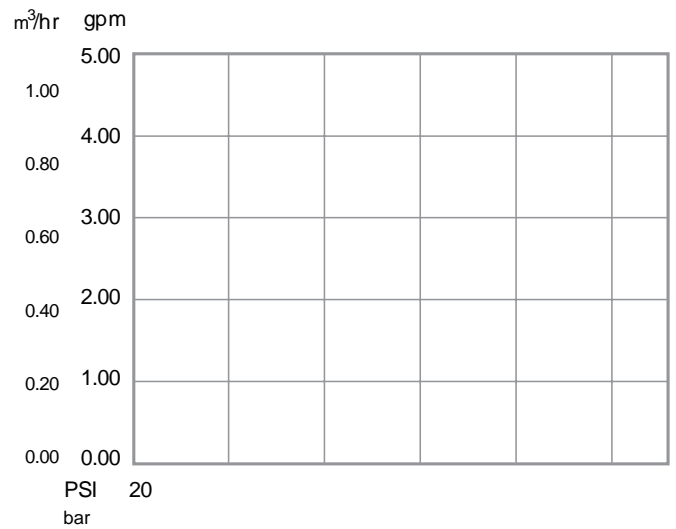
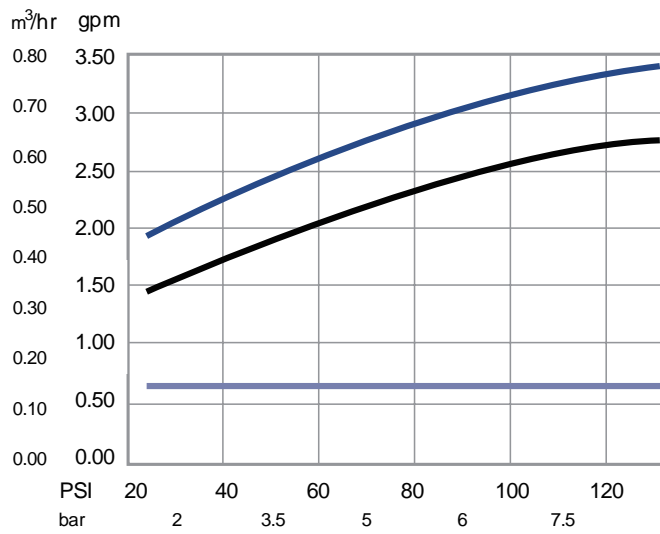
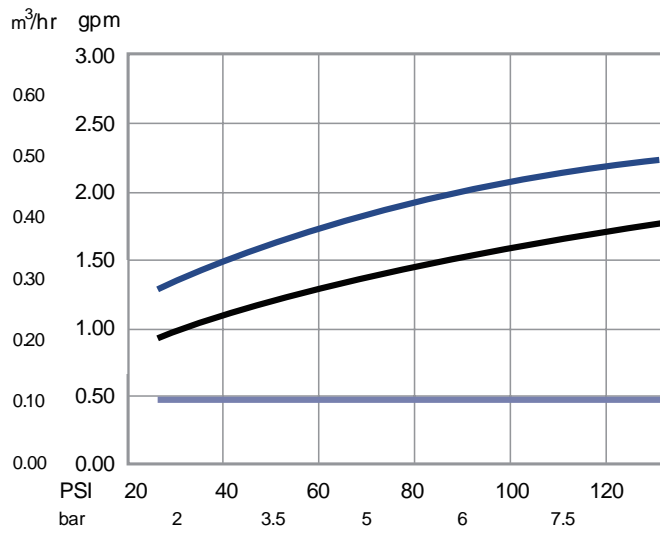

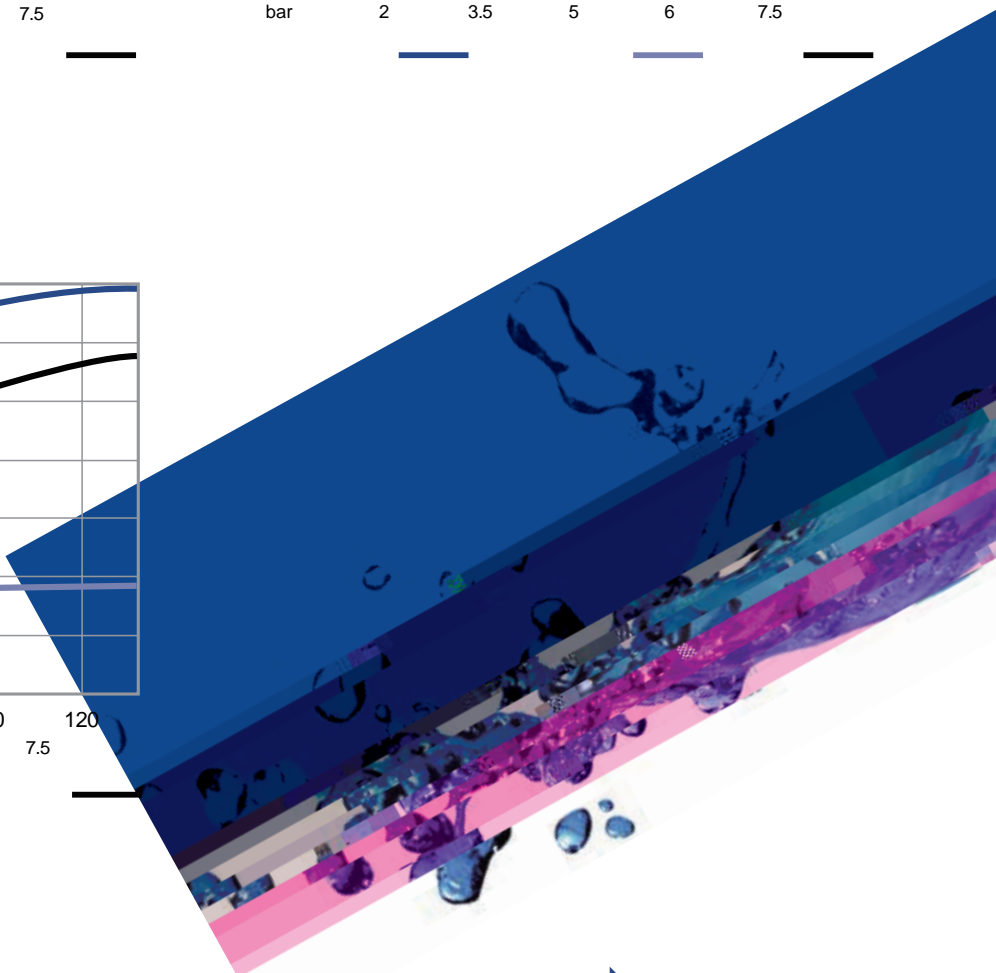
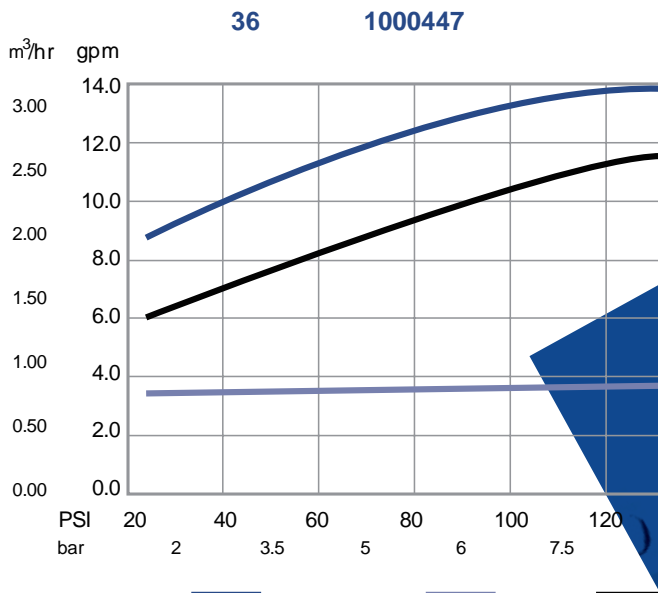
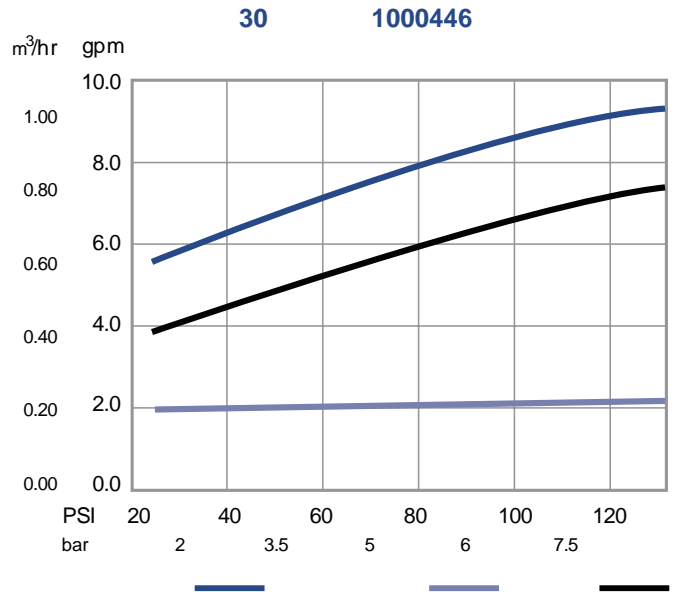
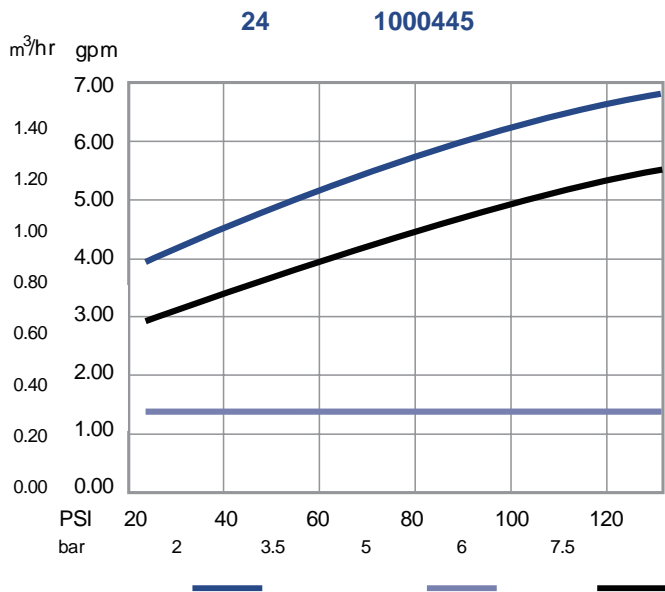

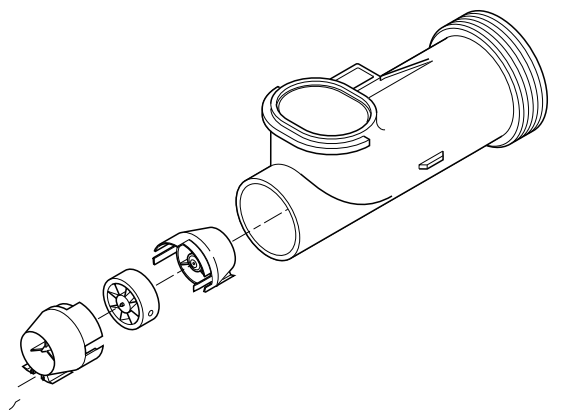

1-1/2 Magnum CV

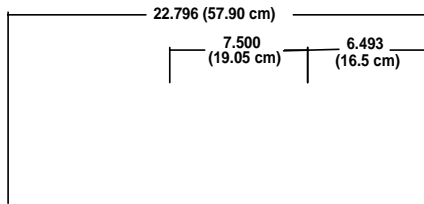

2 Magnum IT

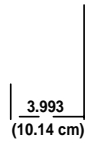

2.817
(7.15 cm)

